

Warnings and Instructions: Review carefully, proper application is required

⚠ Warning: This device will not prevent or eliminate risk of injury. Do Not Overtighten. If swelling, pain, skin irritation, or an unusual reaction occurs, discontinue use immediately and consult your medical professional.

Care: Hand wash using mild soap. Rinse thoroughly. Air dry only. Do not tumble dry.

Application

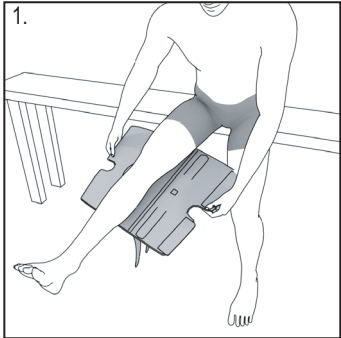

1. Center brace at back of leg.

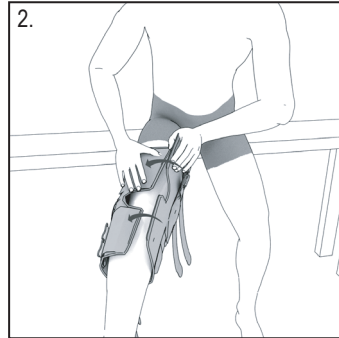

2. Wrap brace around leg and fasten panels at front.

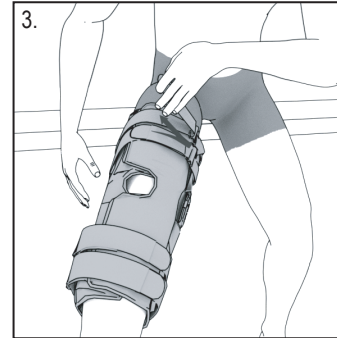

3. Put straps through loop locks, pull and fasten.

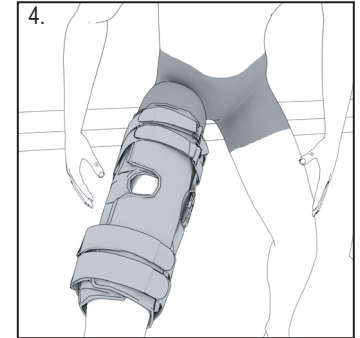

4. Finished application.

Adjusting the Range of Motion Hinges

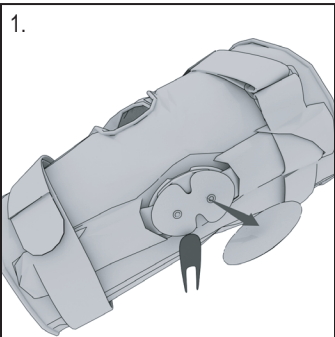

1. To remove the hinge cover cap. Insert the provided tool into the space in the back of the hinge. Using twist or pry motion the cap will come off.

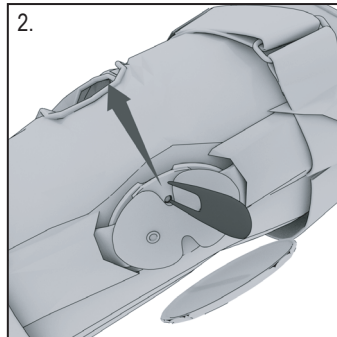

2. Remove the E10 stops that come pre-installed.

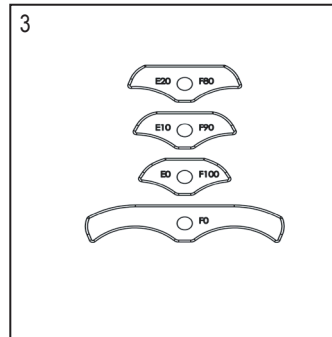

3. Choose the hinge stops with the desired degrees of extension and flexion.

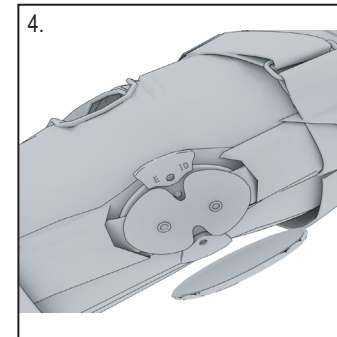

4. Install the extension stop (E) on the extension stop side of the hinge, and the flexion stop (F) on the flexion stop side of the hinge.
The stops for both hinges must be set to the same settings.

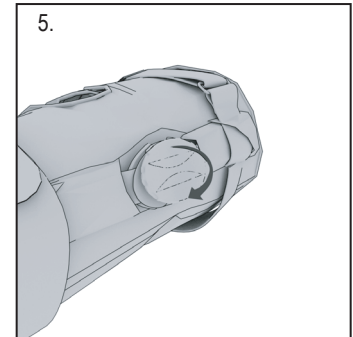

5. Apply the front edge of the cap to the hinge plate first, then press the posterior side to secure.

